

*AquaMate*<sup>®</sup>

# Owner's Manual

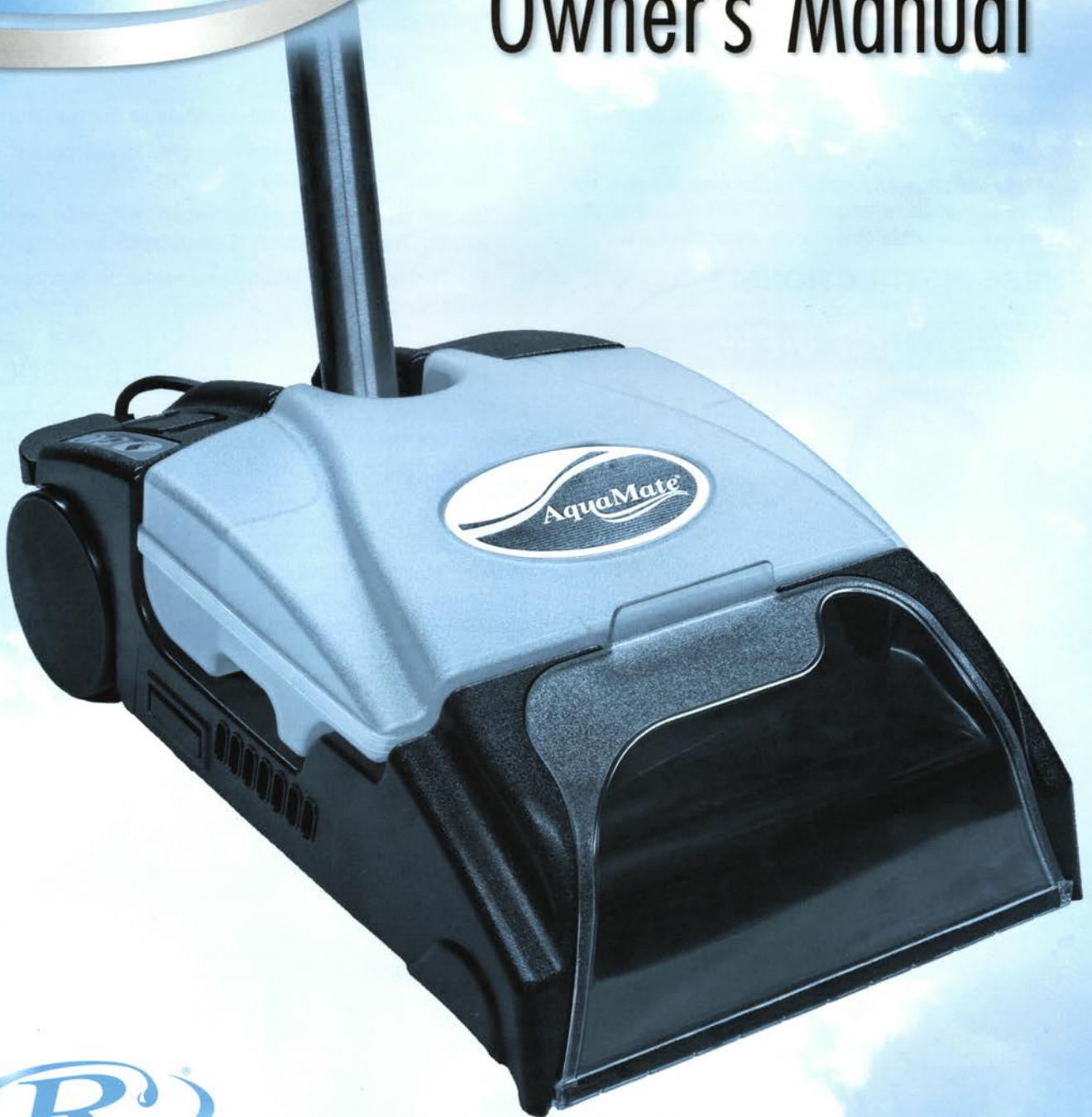

  
RAINBOW<sup>®</sup>

# IMPORTANT SAFETY INSTRUCTIONS

When using an electrical appliance, basic precautions should always be followed, including the following:

**Read all instructions before using this appliance.**

**WARNING**—To reduce risk of fire, electrical shock or injury:

1. Do not leave appliance when plugged in. Unplug from outlet when not in use and before servicing.
2. To reduce the risk of electrical shock, use indoors only.
3. To avoid risk of electrical shock and to reduce risk of fire, use only Rainbow cleaning products intended for use with this machine.
4. To avoid risk of electrical shock, use ONLY the hose supplied with the Rainbow for wet pickup operations. See Rainbow Owner's Manual. Do not modify the electrified plug in any way.
5. The AquaMate contains an electric motor and power cord. To avoid risk of electrical shock, DO NOT immerse the electric cord in water while filling or cleaning the tank.

**SAVE THESE INSTRUCTIONS!**

## PRODUCT VIEW



## REGARDING THE AQUAMATE CLEAN WATER TANK SECTION:

6. **IMPORTANT**—The AquaMate water tank is designed to USE CLEAN, COLD TAP WATER ONLY. To avoid damage to the AquaMate, DO NOT place any of the following into the center water tank:
  - Hot water or liquids.
  - Detergents of any kind, including Rainbow products.
  - Commercially available cleaning liquids or compounds.
7. Use only AquaMate Shampoo or Floor Cleaner in the small side soap tank.
8. Do not use on hardwood, laminate or marble flooring.
9. Ensure the carpet has thoroughly **dried** before using the Rainbow Power Nozzle to vacuum.
10. Do not use the AquaMate when the clean water tank is empty. This could result in damage to the pump.
11. For further safety instructions, refer to Rainbow Owner's Manual.

## SERVICING OF DOUBLE-INSULATED APPLIANCE:

In a double-insulated appliance, two systems of insulation are provided instead of grounding. No grounding means is provided on a double-insulated appliance, nor should a means of grounding be added to the appliance. Servicing a double-insulated appliance requires extreme care and knowledge of the system and should be done only by qualified Rainbow service personnel. Replacement parts for a double-insulated appliance must be identical to the parts they replace. A double-insulated appliance is marked with the words "DOUBLE INSULATION" or "DOUBLE-INSULATED." The symbol (square within a square) may also be marked on the appliance.



**USE THE AQUAMATE® ONLY AS DIRECTED IN THIS OWNER'S MANUAL!  
FOR HOUSEHOLD USE ONLY. Use with the Rainbow E2™ only.**

[www.rainbowsystem.com](http://www.rainbowsystem.com)



# CARPET PREPARATION

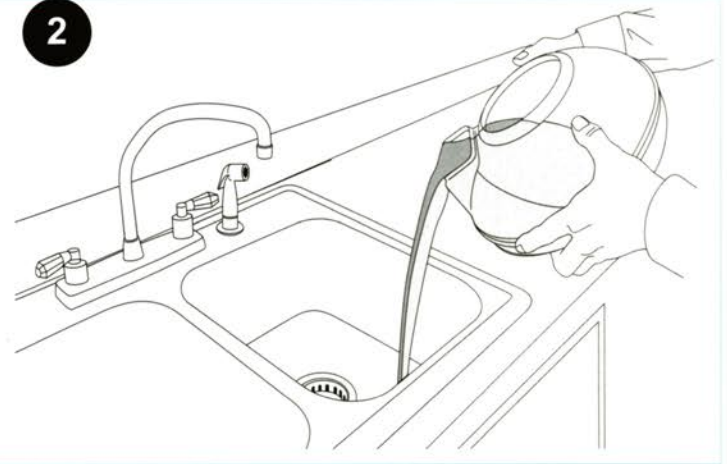
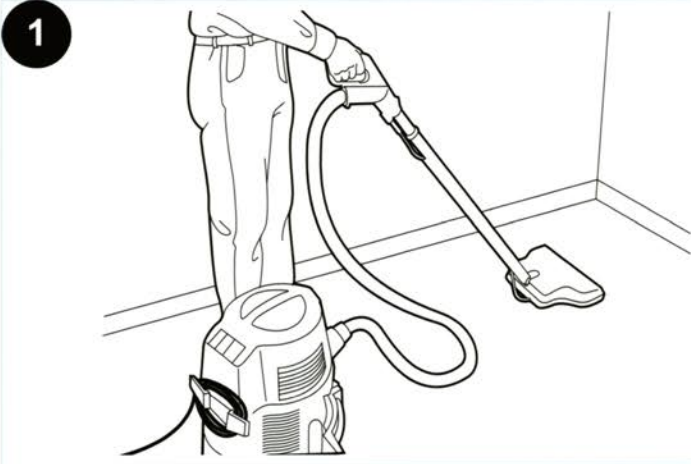

# SETUP

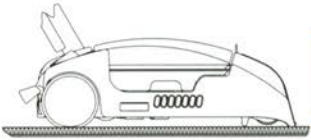
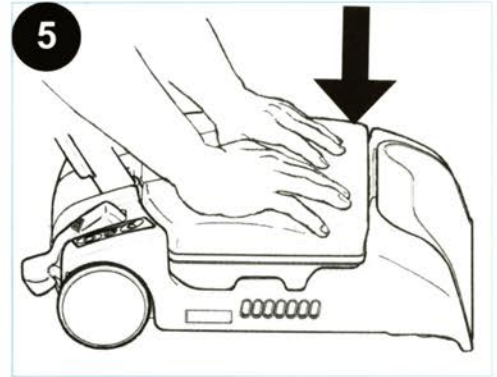
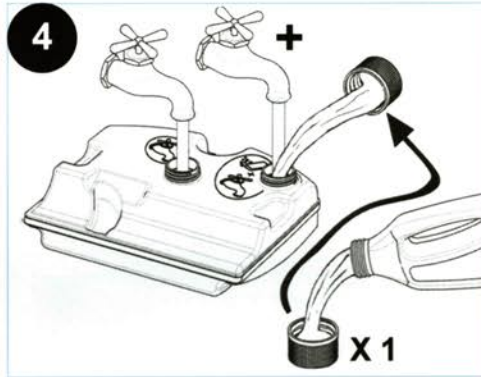
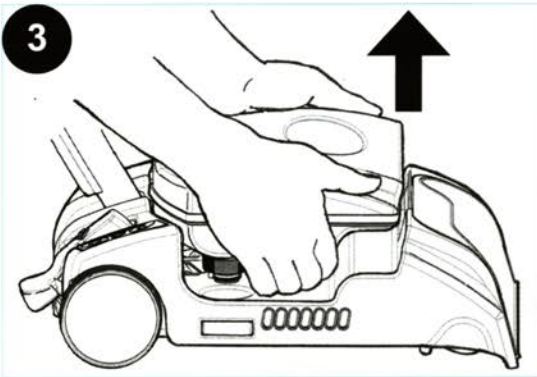

# CARPET CLEANING

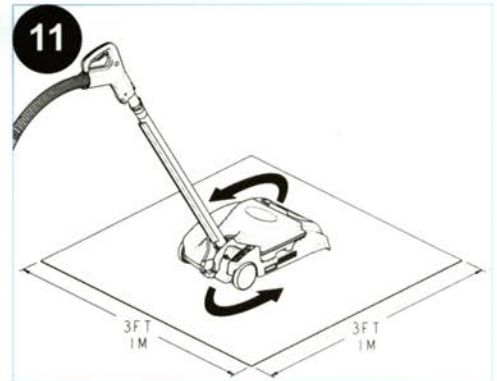
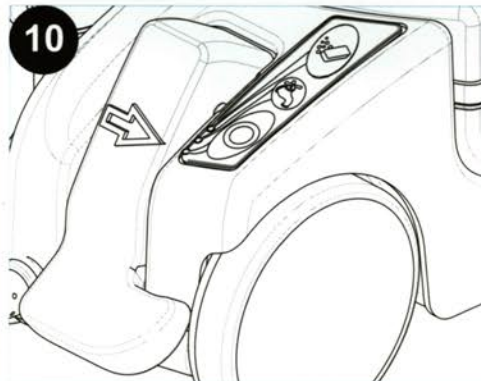
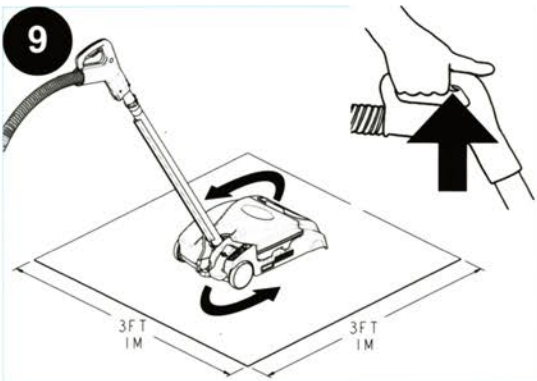
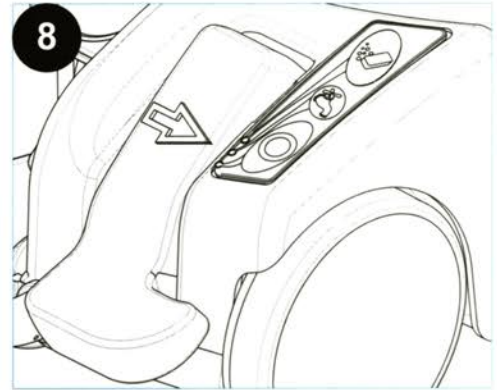
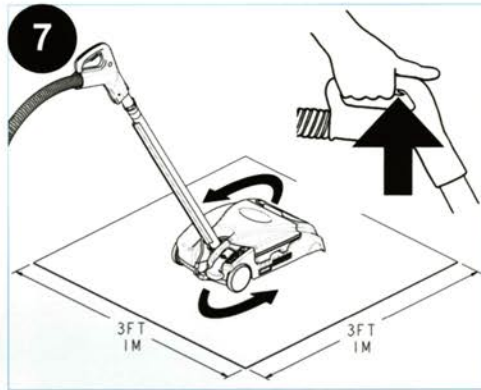
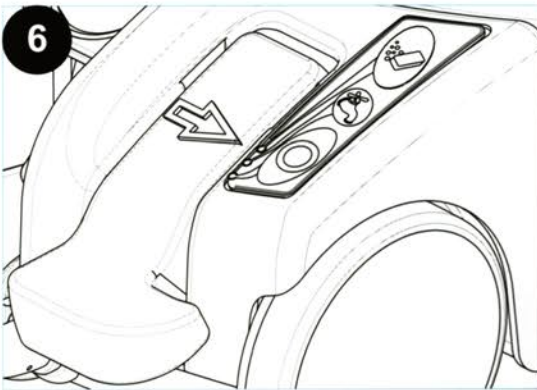

# CLEANUP AND STORAGE

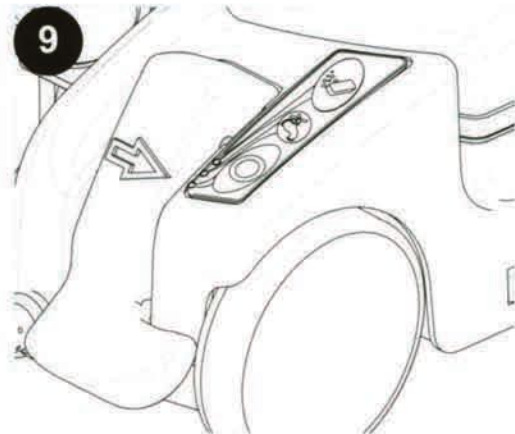
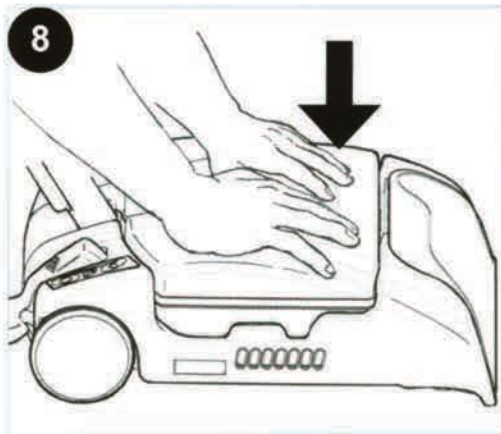
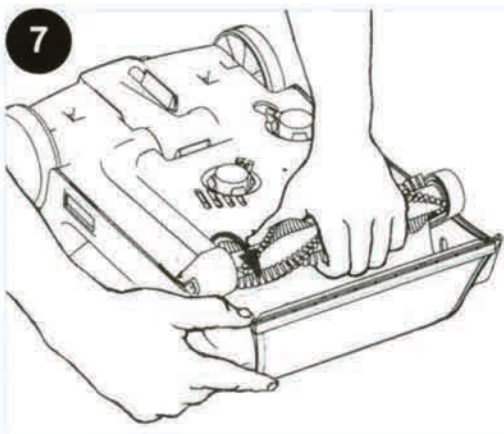
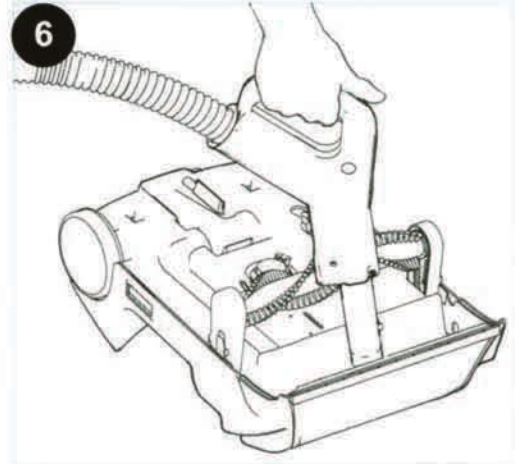
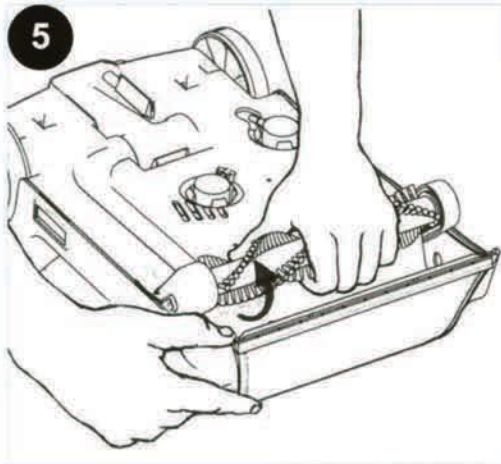
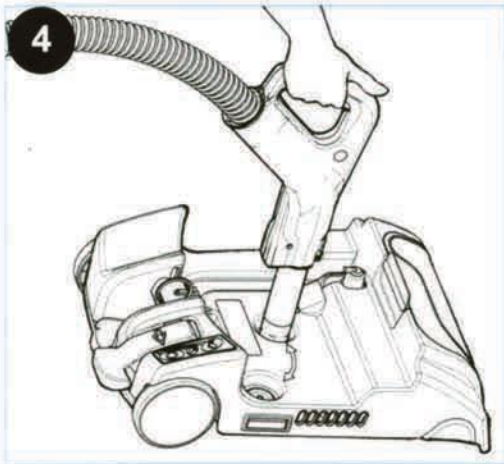
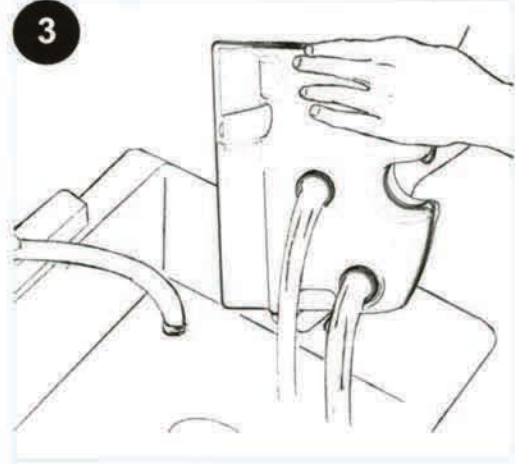
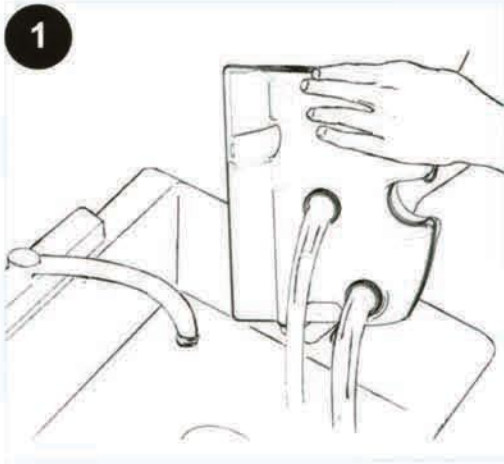

800-523-0510

[www.rainvac.com](http://www.rainvac.com)

R13986A-0  
©Rexair 2009